

System 3R

# WorkPal 1



# Swedish design and quality

# Contents

System 3R Automation solutions	4
Technical specifications	8
WorkShopManager	10
Customer Services	12
GF Machining Solutions	14



## Automation made simple

- Smallest footprint
- Loading the table of your Milling, WEDM, Laser or grinding machine
- Easy to operate, glass doors gives maximum visibility and access to the magazine.

**Achieve greater return on your investment!**

# Small footprint!

WorkPal 1 is a pallet changer that requires minimal floor space. It is designed for automatic changing of pallets in chucks on machine tables in:

- milling machines
- wire EDM machines
- laser machines
- grinding machines.

With glass doors across one full side, the WorkPal 1 gives maximum access to the magazine. This greatly facilitates the loading and unloading of pallets.

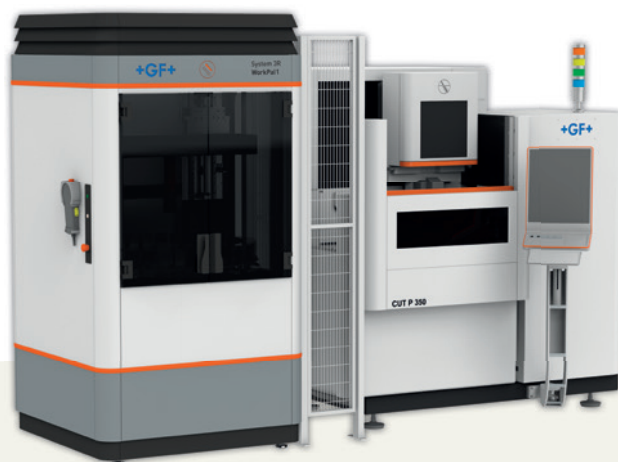

## Wire-cutting EDM (wireEDM) application WorkPal 1

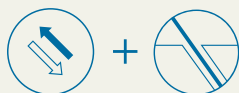

The changing arm lifts the pallets over the tank in WEDM machines.



## Milling application WorkPal 1

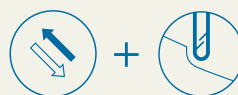

# System 3R Automation

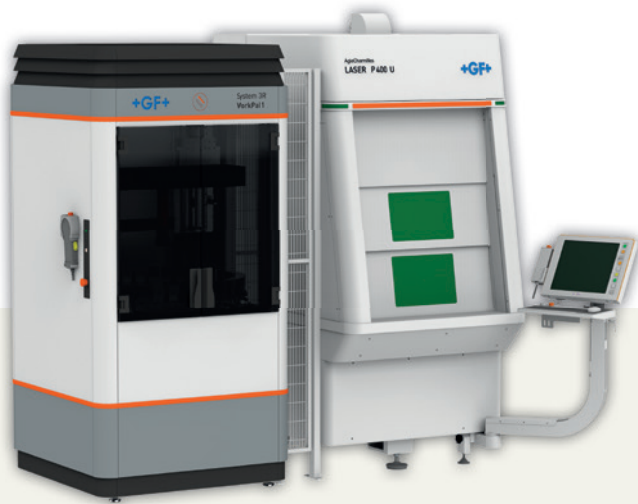

**Laser application**  
WorkPal 1

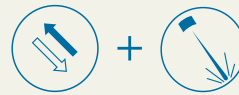

## Flexibel magazine configuration

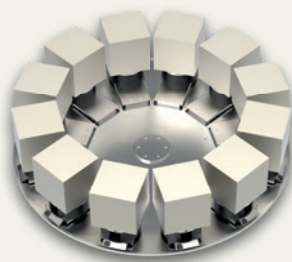

12 positiones ...

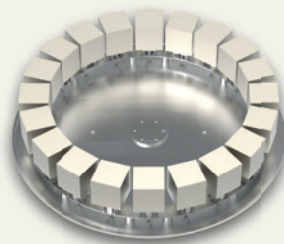

20 positiones ...

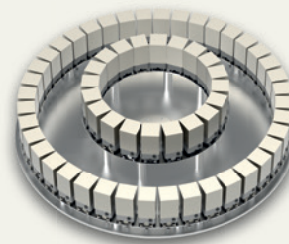

or 60 positiones

# System 3R Automation



## Specifications, WorkPal 1

Maximum handling weight (incl. gripper, pallet, etc.)	50 kg
Maximum number of machines served	1
Maximum number of tooling types	1
Chuck adapter support	-
Technology	Milling, wire EDMing, grinding, laser and CMM
Linear rail	■ Manual movement
Loading station support	-
Tilting and draining station support	-
Drying station support (wire EDM)	■
BatchBuilder	■
CellManager	■
EasyCellManager (milling, laser)	■
Hybrid station support (milling)	-
Pallet station support (milling)	-

# System 3R Automation

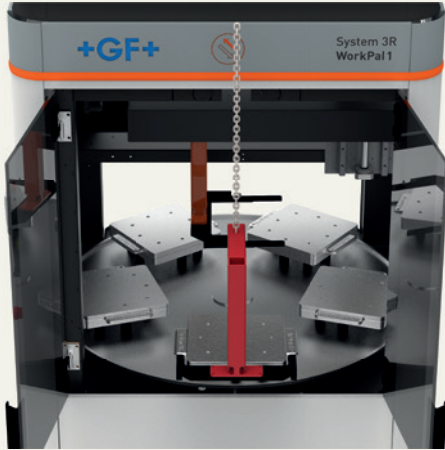

The design allows loading of heavy work pieces with an overhead crane.

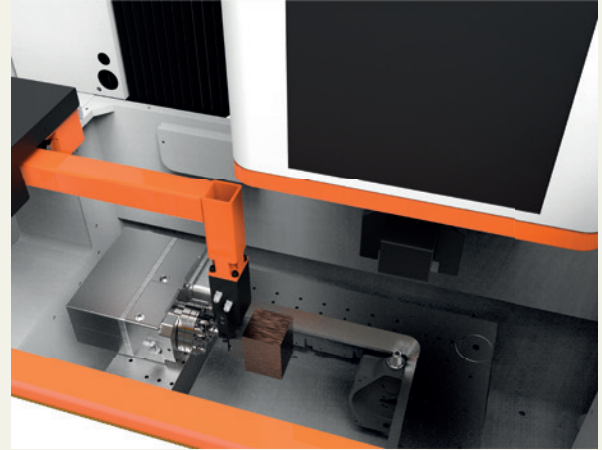

WorkPal 1  
Application example: B-axis for Wire-cutting EDM (wire EDM).

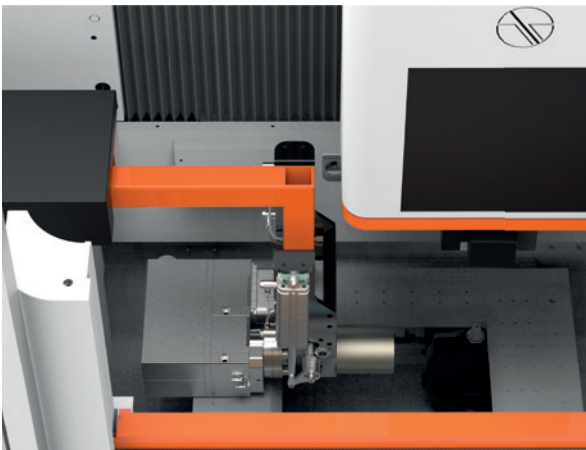

WorkPal 1  
Application example: Tilt gripper for Wire-cutting EDM (wire EDM).

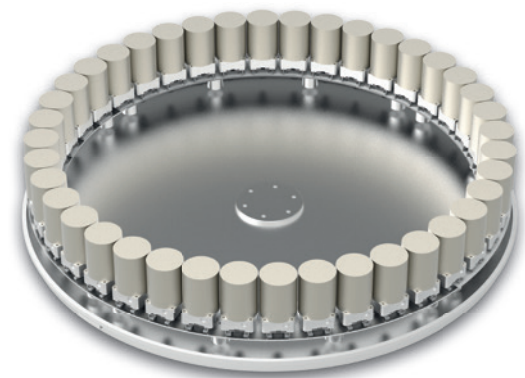

WorkPal 1  
Optional: Magazine disc for Tilt gripper.

Magazine capacity/application	Pallet system	No of positions
Table chuck – milling, grinding or EDM	Macro 54 & 70	24, 40 or 60
	Macro with chip guard	24
	MacroPT	60
	Matrix 110	20
	GPS 70	24, 40 or 60
	GPS 120	20
	Macro Ø 116	20
	MacroMagnum	6, 10 or 12
	Matrix 142	6, 10 or 12
	GPS 240	7
	Dynafix	5
	UPC (fork gripper or RCS)	4
	ITS 50	24, 40 or 60
	ITS 148	6, 10 or 12
Table chuck – wire EDM	Macro WEDM	12
	MacroTwin WEDM	4
	PSW (RCS gripper)	12
Wire EDM B-axis	Macro 54 & 70	12, 24 or 40
	ITS 50	12, 24 or 40

## Technical specifications

No expensive machine modifications are required. The changing arm lifts pallets over the tank in wire EDM machines.

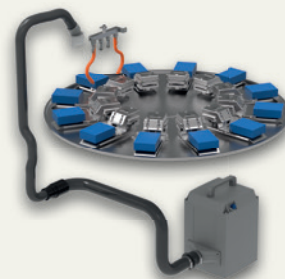
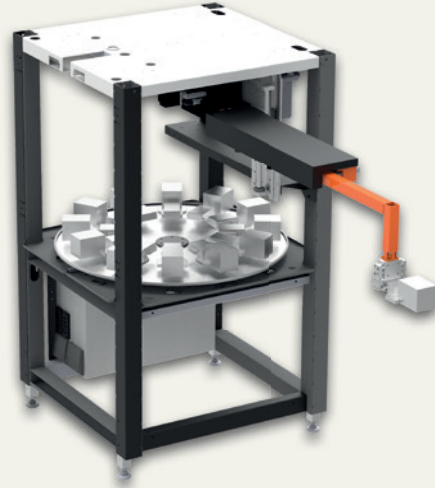
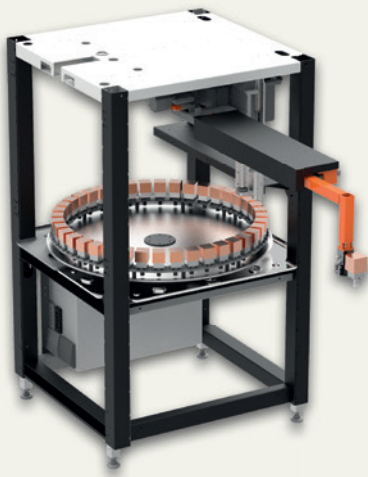

Optional for WorkPal – Drying station



# Technical specifications

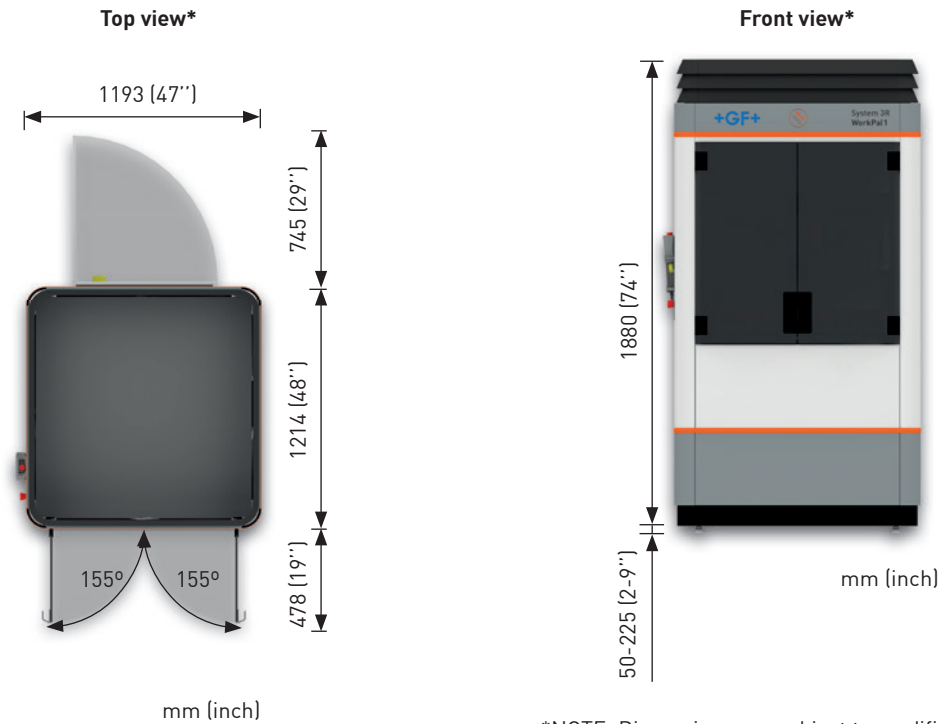

\*NOTE: Dimensions are subject to modifications. Since new design is not yet released.

## Technical specifications

Transfer weight (may be limited by the pallet system)	50 kg (pallet with workpiece) 111 lbs (pallet with workpiece)
Maximum total weight in the magazine	300 kg 667 lbs
MR, X and Z axes	AC servo motor
Maximum horizontal stroke (X) and speed	828 mm, Speed 1200 mm/s 32.6 in
Maximum vertical stroke (Z) and speed	400 mm, Speed 650 mm/s 15.7 in
Maximum MR axis stroke and speed	360°, Speed 90°/s
Required power supply	single-phase, 180–240 V AC, 14 A at 180 V AC, 20 A at 230 V AC.
Required air pressure	6 ± 1 bar, 150 litres/minute
Required floor space	1200 x 1214 mm 47 x 48 in
Interface – serial RS232/422, M function or parallel I/O	

## Options & accessories

In-built lighting	
Integrated drying station with/without thermostat for temperature control	
ID-system with or without automatic scanning	
Cell PC with WorkShopManager software	
Chip guard for Macro 54 & 70	U-50167.55
Code carrier	3R-863.01-10, 3R-863.01-10M, 3R-863.25-10, 3R-863.30-10 or C690 800

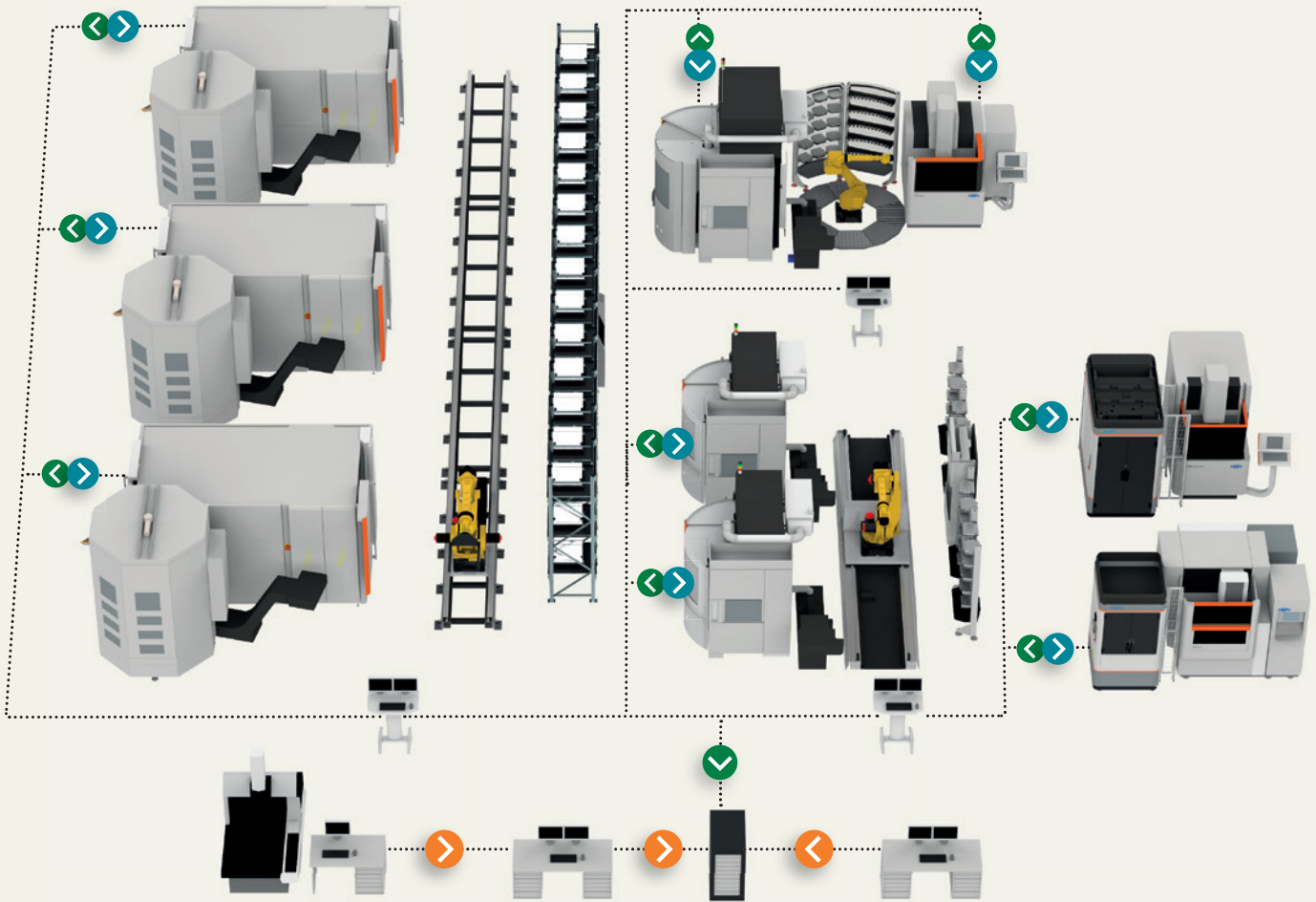

WSM – WorkShopManager

# User-friendly Cell Management Software

- Necessary data is entered quickly and in a structured manner.
- Quick, precise overview of the entire process chain
- Increased flexibility: The order of priority can be changed at any time.
- Simpler, safer preparation of automated cells
- The risk of errors due to the human factor is minimized.
- Increased process security



## ➤ Preparation – WorkCenter

- Create an order
- Assign operations and NC programs
- Retrieve offset values
- Release the order for production

## ➤ Monitoring – CellMonitor

- Display status of all cells
- Display status of individual machines and processes

### Statistics – WSM Statistics

- Retrieve and analyze cell utilization data
- Retrieve and analyze order data

## ➤ Execution – CellManager

- Manages the pallet ID codes and magazine positions
- Creates priority lists
- Automatically starts available jobs in the order of the priority list
- Updates the information in the database with the status and machining times of individual orders

# Optimize the uptime of your equipment with our Machine Support services

Annual reconditioning minimizes production stops and optimizes function, precision and performance. GF Machining Solutions offers comprehensive services for your Automation, reference systems and masters and calibration tools.

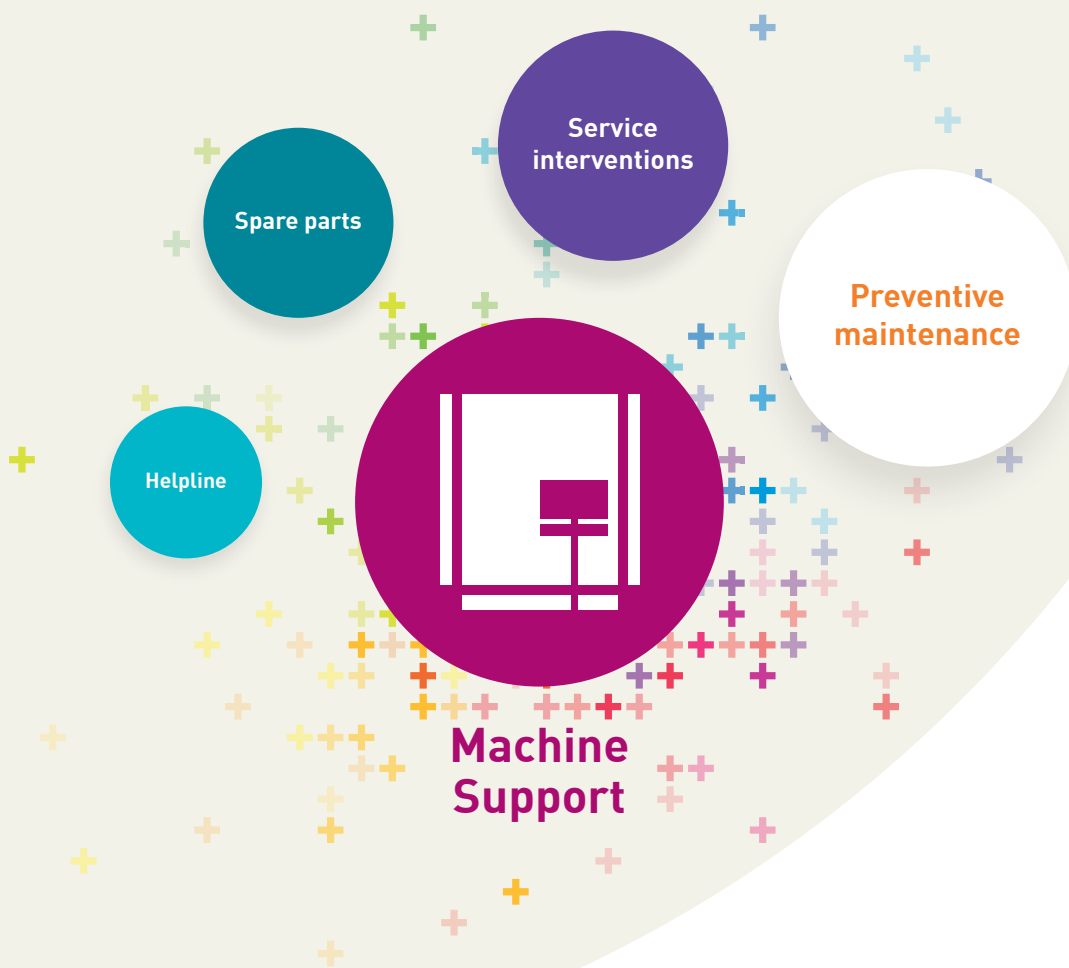

# Preventive maintenance

---

## Automation

- Mechanics
- Pneumatics
- Peripheral equipment

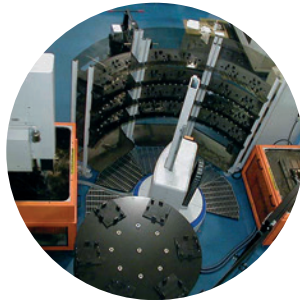

## Reference systems

- Rebuilding chucks
- Inspecting references
- Checking clamping force

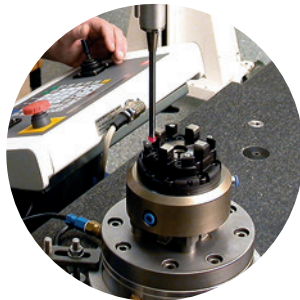

## Masters and calibration tools

- Cleaning and polishing
- CMM inspection
- Quality certificate



## CE Certification

GF Machining Solutions' Customer Services also offers CE Certification of Conformity for complete Automation cells.

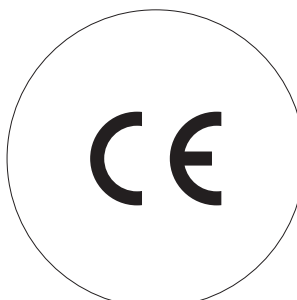

# GF Machining Solutions



## Milling

**High-Speed and High-Performance Milling Centers.** In terms of cutting speed, HSM centers are 10 times faster than conventional milling machines. Greater accuracy and a better surface finish are also achieved. This means that even tempered materials can be machined to a condition where they are largely ready to use. One essential advantage of HSM is that with systematic integration, the process chain can be significantly shortened. HSM has developed alongside EDM into one of the key technologies in mold and tool making.



## EDM

**Electric Discharge Machines.** EDM can be used to machine conductive materials of any hardness (for example steel or titanium) to an accuracy of up to one-thousandth of a millimeter with no mechanical action. By virtue of these properties, EDM is one of the key technologies in mold and tool making. There are two distinct processes — wire-cutting EDM and die-sinking EDM.



## Laser

**Laser texturing.** Laser texturing supplements and extends the technologies offered by GF Machining Solutions. With our laser technology we enable you to produce texturizing, engraving, microstructuring, marking and labeling of 2D geometries right through to complex 3D geometries. Laser texturing, compared to conventional surface treatment using manual etching processes, offers economic, ecological and design advantages.



## Automation

**Tooling, Automation, Software.** Tooling for fixing workpieces and tools; automation systems and system software for configuring machine tools and recording and exchanging data with the various system components and design advantages.



## Customer Services

**Operations, Machine and Business Support.** Customer Services provides with three levels of support all kind of services for GF Machining Solutions machines. Operations Support offers the complete range of original wear parts and certified consumables including wires, filters, electrodes, resin and many other materials. Machine Support contains all services connected with spare parts, technical support and preventive services. Business Support offers business solutions tailored to the customer's specific needs.

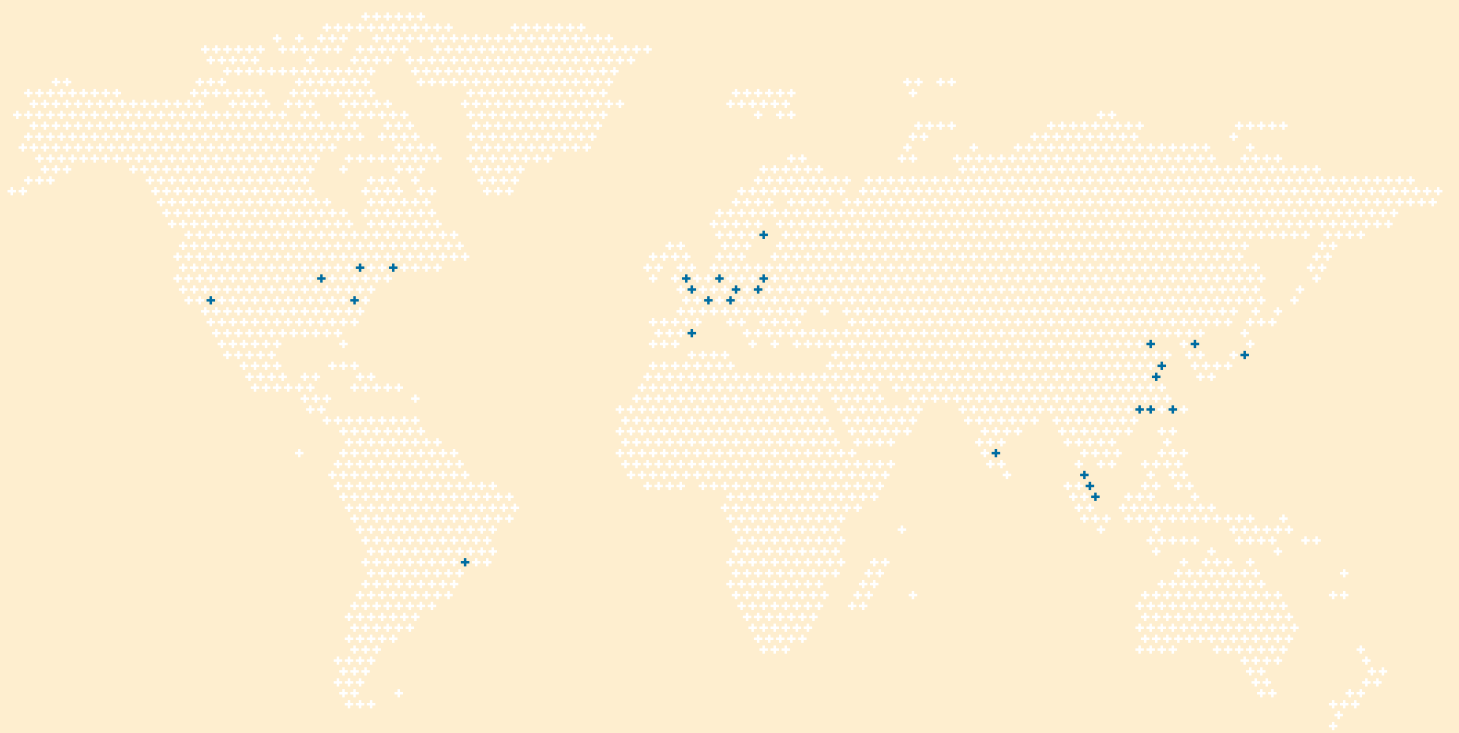

## At a glance

We enable our customers to run their businesses efficiently and effectively by offering innovative Milling, EDM, Laser and Automation solutions. A comprehensive package of Customer Services completes our proposition.

[www.gfms.com](http://www.gfms.com)

